

1 2 3 4 5 6

A

B

C

D

A

B

C

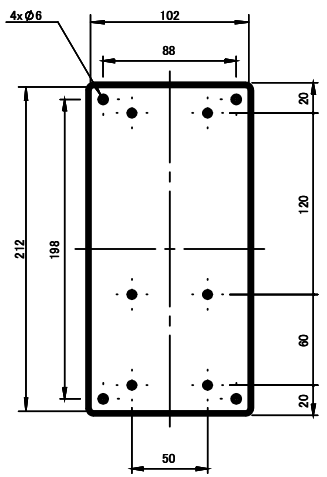
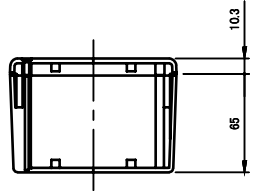
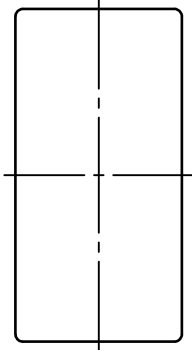
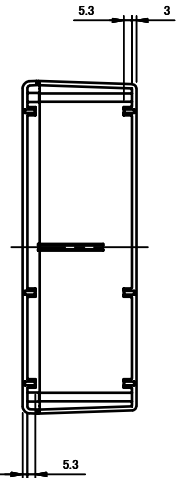
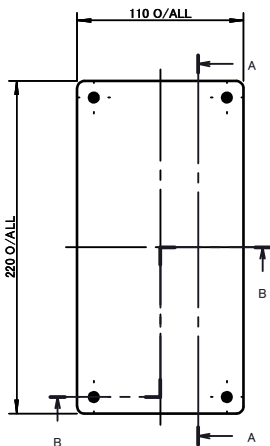
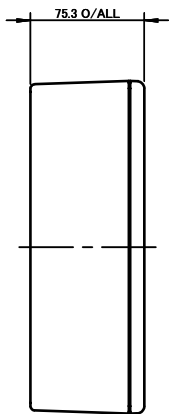
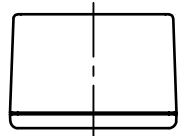

TOP

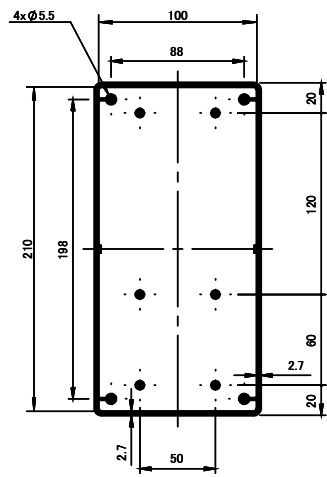

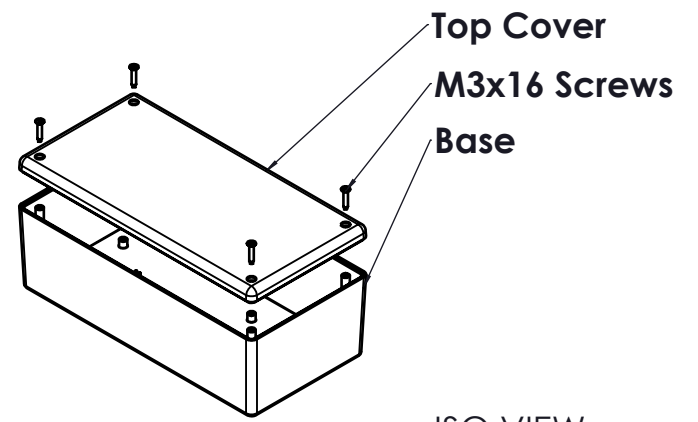

BASE

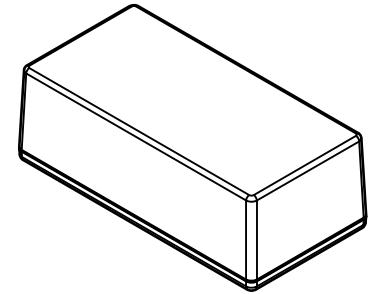

ISO VIEW
1:5



 CAMDENBOSS JAMES CARTER RD, MILDENHALL, SUFFOLK. IP28 7DE TEL: 01638 716101 FAX: 01638 716554 EMAIL: Sales@CamdenBoss.com WEB: www.CamdenBoss.com		UNLESS OTHERWISE SPECIFIED: DIMENSIONS ARE IN MILLIMETERS		DO NOT SCALE DRAWING		REVISION. ○	
		GENERAL TOLERANCES +/- 0.2		TITLE: 82 SERIES MULTI-PURPOSE CASES, SIZE 18, BLACK, 220x110x75.3			
		FINISH. FINE TEXTURE		MATERIAL. ABS UL94-HB		DWG NO. CUE8218BK	
DRAWN LEWIS LETCHFORD		SIGNED L.L.		DATE 10/01/14		SCALE: 1:5	
CHK'D -		-		-		SHEET 1 OF 1	
		PROJECTION.				A4	

1 2 3