

1 2 3 4 5 6

A

B

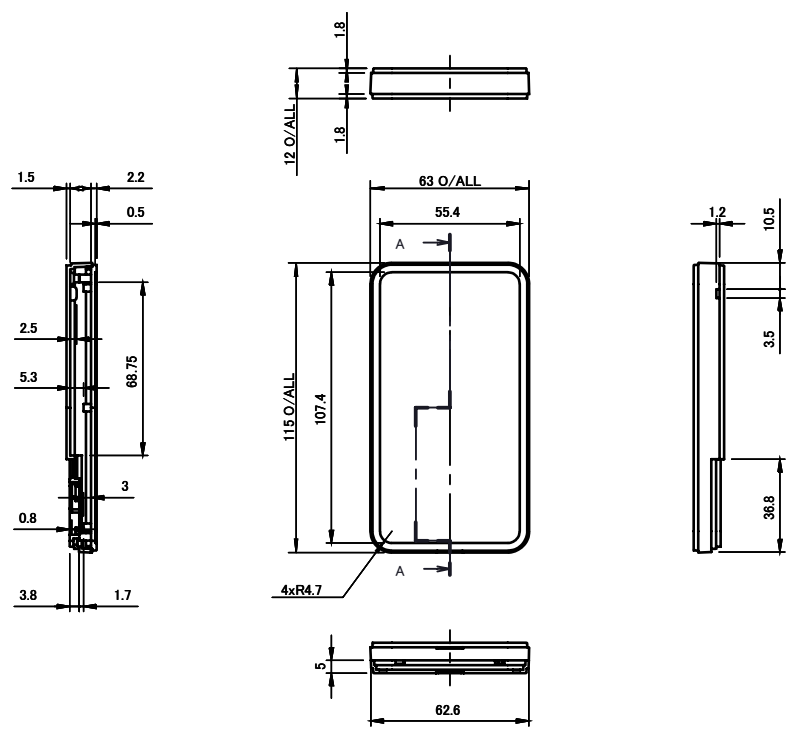

C

D

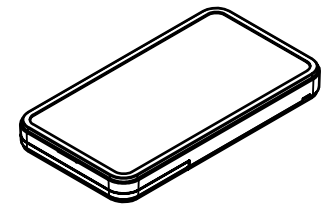
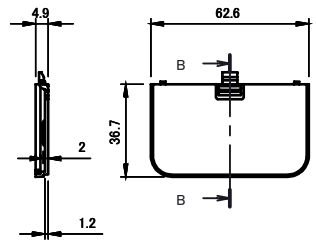
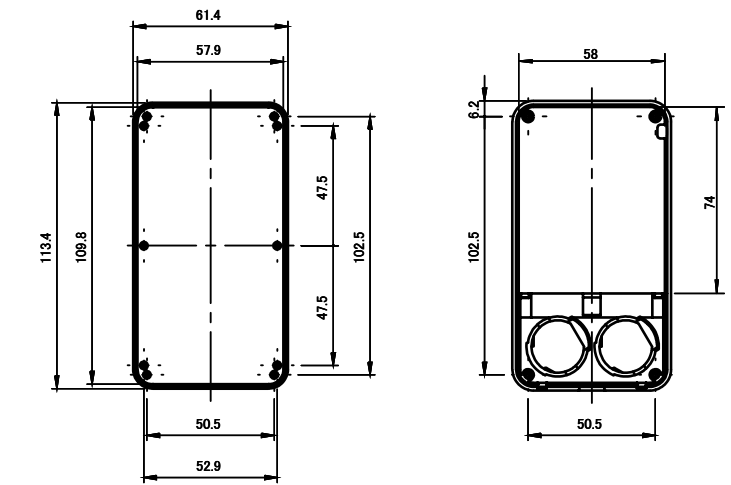
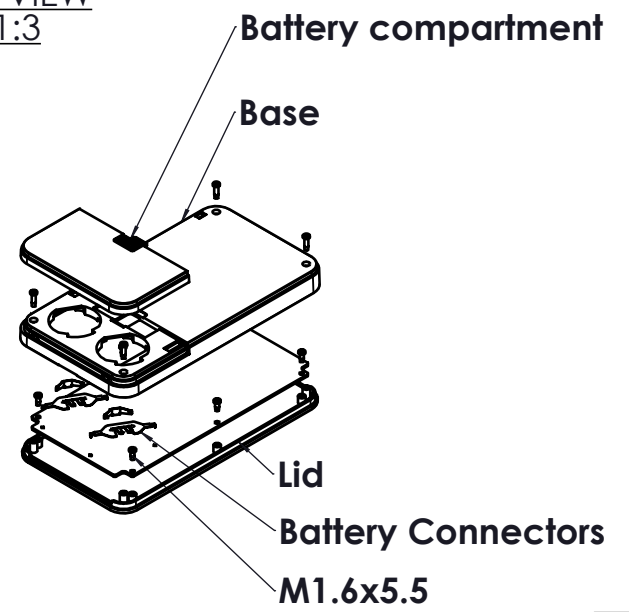

ISO VIEW
1:3



 CAMDENBOSS JAMES CARTER RD, MILDENHALL, SUFFOLK. IP28 7DE TEL: 01638 716101 FAX: 01638 716554 EMAIL: Sales@CamdenBoss.com WEB: www.CamdenBoss.com		UNLESS OTHERWISE SPECIFIED: DIMENSIONS ARE IN MILLIMETERS		DO NOT SCALE DRAWING		REVISION. ○	
		GENERAL TOLERANCES +/- 0.2		TITLE: 80 SERIES SLIM PLASTIC ENCLOSURE, BLACK, 115x63x12			
DRAWN		NAME		MATERIAL.		DWG NO.	
LEWIS LETCHFORD		L.L.		ABS UL94-HB		CHH803BBK	
CHK'D		SIGNED		PROJECTION.		SCALE: 1:3	
-		-				SHEET 1 OF 1	
DATE		DATE		DATE		DATE	
29/01/2014		-		-		-	

1 2 3 4 5 6

A

B

C

D

A4