

Section A-A

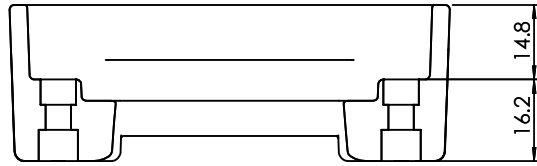

ISO VIEW

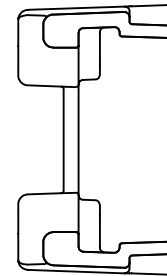
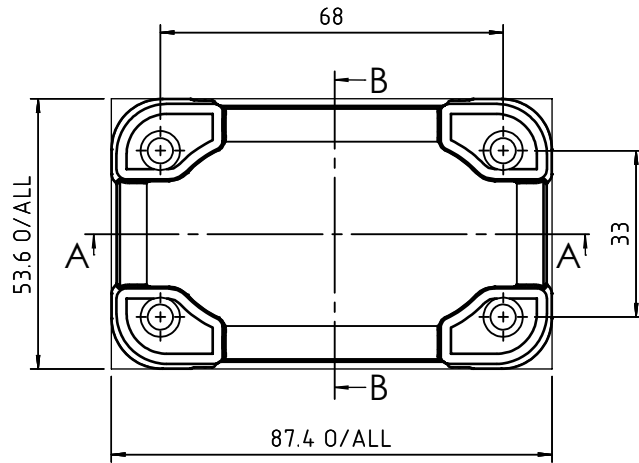
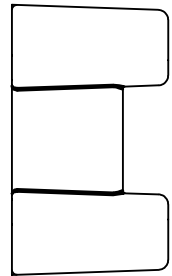
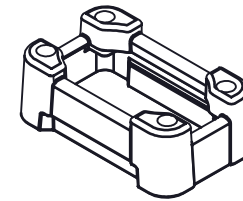

Section B-B

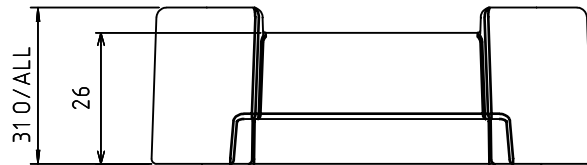
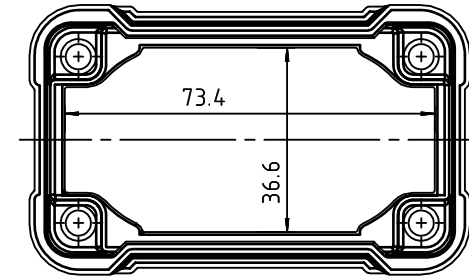



Spacer



Blind Cap



Screws

 CAMDENBOSS JAMES CARTER RD, MILDENHALL, SUFFOLK. IP28 7DE TEL: 01638 716101 FAX: 01638 716554 EMAIL: Sales@CamdenBoss.com WEB: www.CamdenBoss.com				UNLESS OTHERWISE SPECIFIED: DIMENSIONS ARE IN MILLIMETERS	DO NOT SCALE DRAWING	REVISION. 
				GENERAL TOLERANCES +/- 0.2	TITLE: 88 SERIES SILICONE BOOTS, SIZE2, BLACK 87.4x53.6x31	
	NAME	SIGNED	DATE	FINISH. SMOOTH	MATERIAL. SILICONE	DWG NO. CDM88B2BK
DRAWN	LEWIS LETCHFORD	LL	07/03/2014	PROJECTION. 	SCALE. 2:3	SHEET 1 OF 1
CHK'D	-	-	-			A4