

1 2 3 4 5 6

A

A

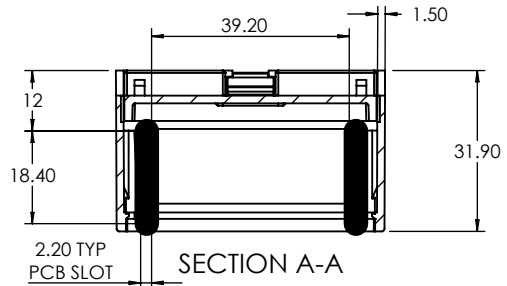

ISO VIEW  
1:3

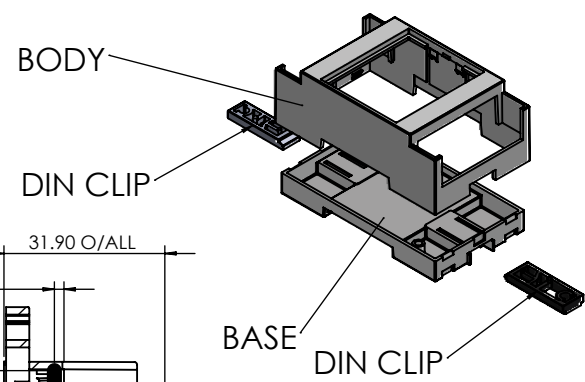

B

B

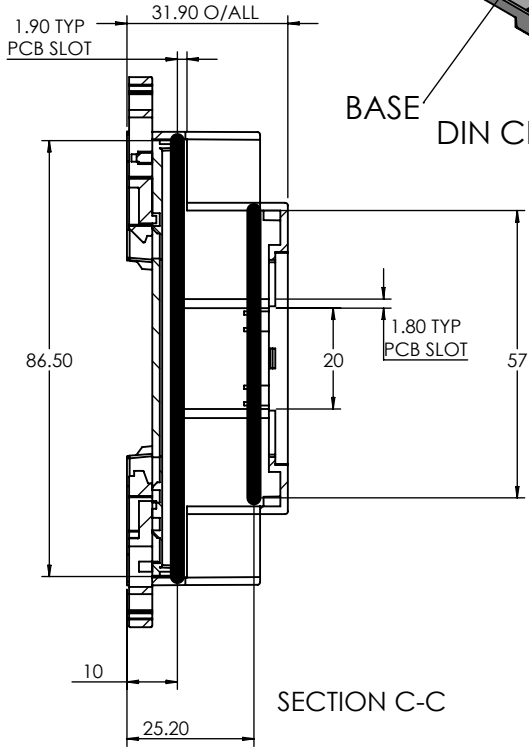
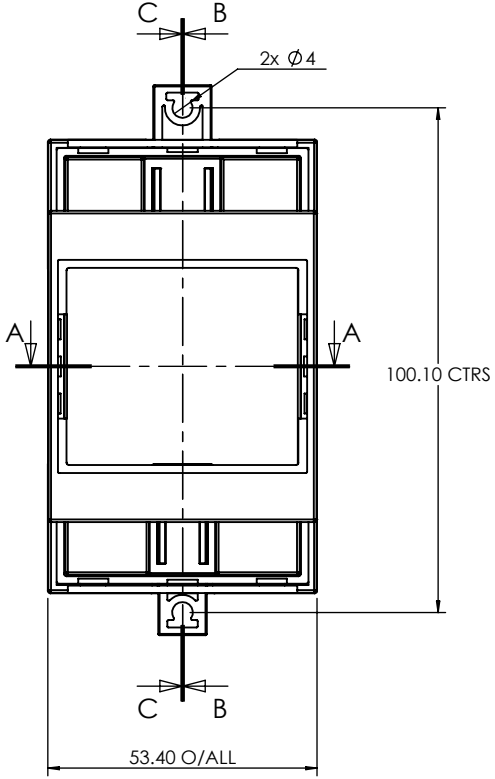
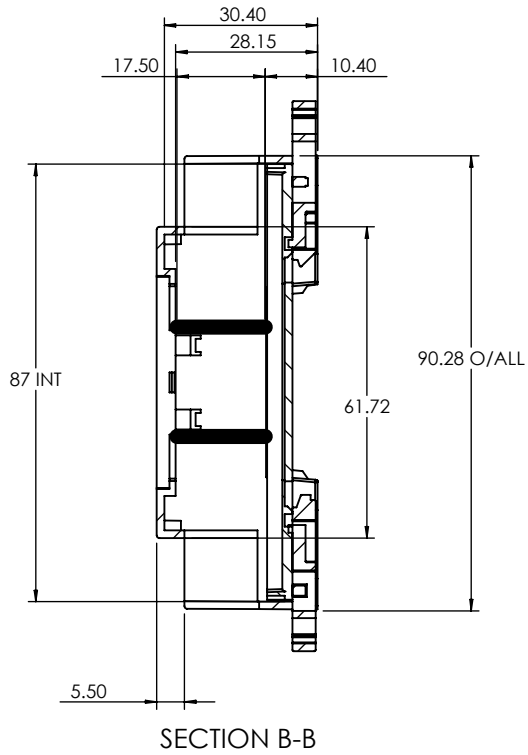



C

C

D

D

DIN CLIPS ARE SHOWN IN WALL MOUNTING POSITION

 <b>CAMDENBOSS</b> JAMES CARTER RD, MILDENHALL, SUFFOLK. IP28 7DE TEL: 01638 716101 FAX: 01638 716554 EMAIL: Sales@CamdenBoss.com WEB: www.CamdenBoss.com		UNLESS OTHERWISE SPECIFIED: DIMENSIONS ARE IN MILLIMETERS	DO NOT SCALE DRAWING	REVISION. <input type="checkbox"/>
		GENERAL TOLERANCES +/- 0.2	TITLE: <b>GENERAL ASSEMBLY DRAWING FOR CDIB SERIES</b>	
		FINISH: FINE TEXTURE	DWG NO. <b>CDIB-3-L2</b>	
DRAWN: IAN PAGANO	SIGNED: I.P.	DATE: 22/03/17	MATERIAL: UL94 - V0 PC RAL: 7035	A4
CHKD: ALWIN B.K.	SIGNED: A.BK.	DATE: 05/12/17	PROJECTION: 	SCALE: 2:3
			SHEET 1 OF 1	

1 2 3