

# ASSEMBLY

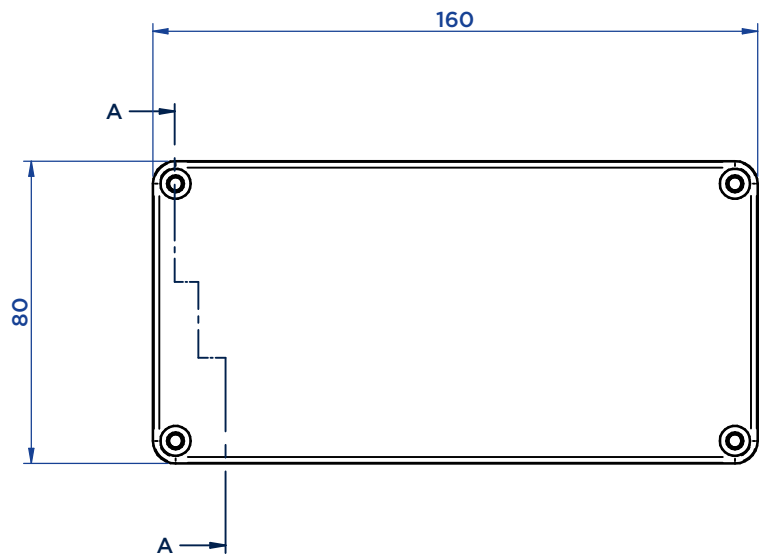

# LID

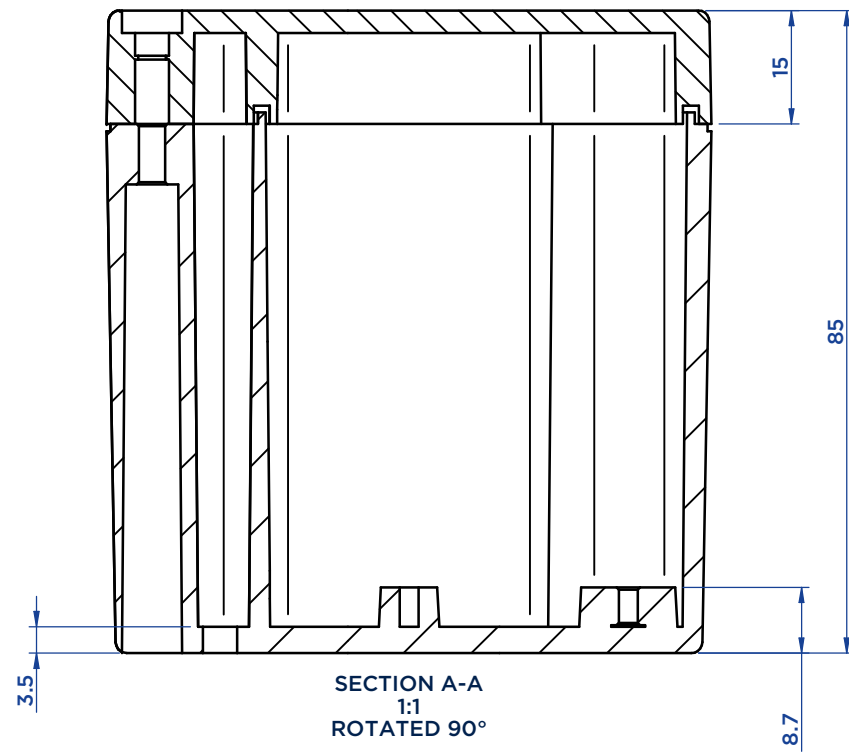
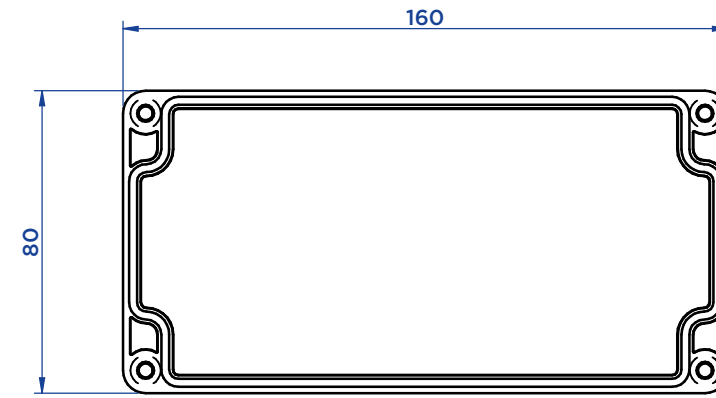

# BODY

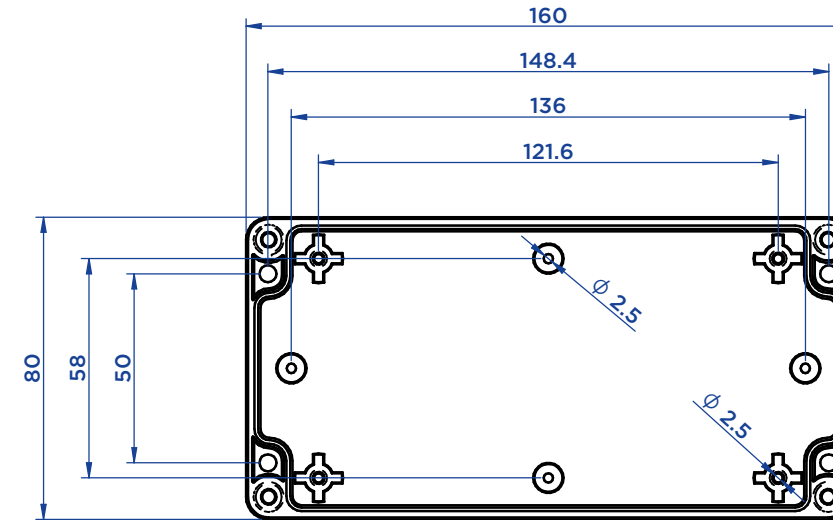

-			-		<b>CAMDENBOSS</b> <small>CONNECT. ENCLOSE. INNOVATE.</small>	COLOUR: SEE DATASHEET	GAUGE:	DO NOT SCALE DRAWING DEBURR AND BREAK SHARP EDGES	SCALE: <b>1:2</b>
A	08.03.24	522	UPDATED TO LATEST CAD MODEL			S. HARDINGE	FINISH: SMOOTH	TITLE: GNL ASSEMBLY DRG FOR 7300 SERIES SIZE 369	
O	26.02.09	-	FIRST DRAWN		L. SUBKHANKULOVA	DRAWING UNITS: MILLIMETERS TOLERANCES: SEE CRITICAL DIMENSIONS	PROJECTION	MATERIAL: PC	DWG NO: 7200_265 -A
REVISION	DATE	INPD #	DESCRIPTION		COMPLETED BY				<b>A3</b>