

SECTION B-B

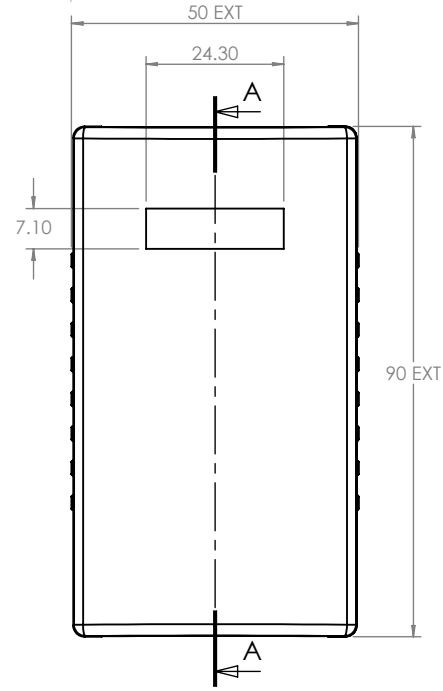

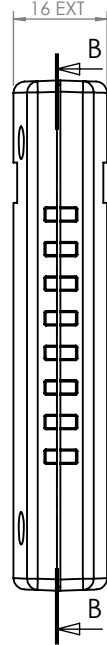

SECTION A-A

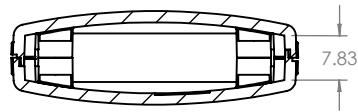
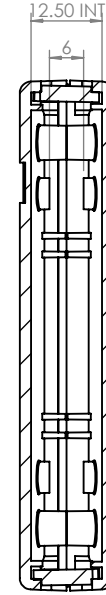

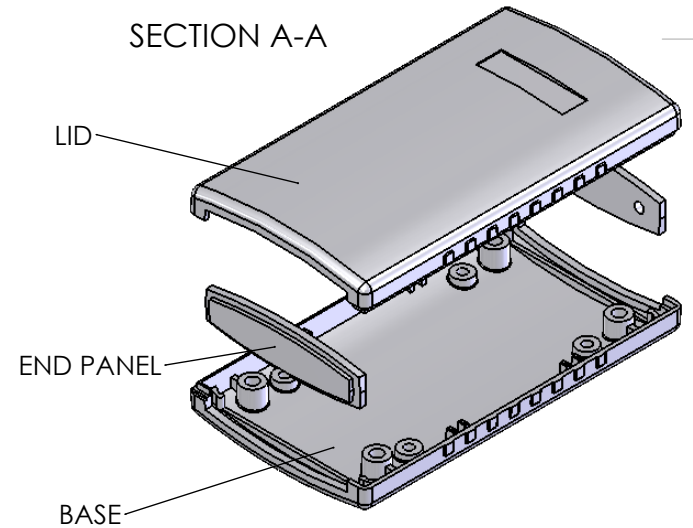
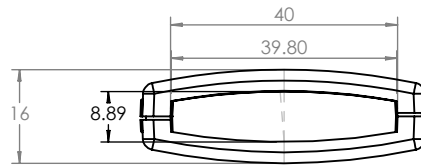
SECTION C-C



 <b>CAMDENBOSS</b> JAMES CARTER RD, MILDENHALL, SUFFOLK. IP28 7DE TEL: 01638 716101 FAX: 01638 716554 EMAIL: Sales@CamdenBoss.com WEB: www.CamdenBoss.com				UNLESS OTHERWISE SPECIFIED: DIMENSIONS ARE IN MILLIMETERS		DO NOT SCALE DRAWING		REVISION. 0	
				GENERAL TOLERANCES +/- 0.2		TITLE: <b>GENERAL ASSY FOR DRAWING 3400 SERIES</b>			
				FINISH. <b>TEXTURED</b>		MATERIAL. <b>ABS</b>		DWG NO. <b>3400-30</b>	
DRAWN: JAMIE JACOBS				SIGNED: JNJ		DATE: 08/11/12		SCALE: 3 : 4	
CHKD: -						PROJECTION. 		SHEET 1 OF 1	