

SECTION B-B

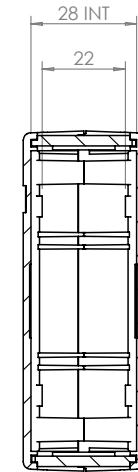

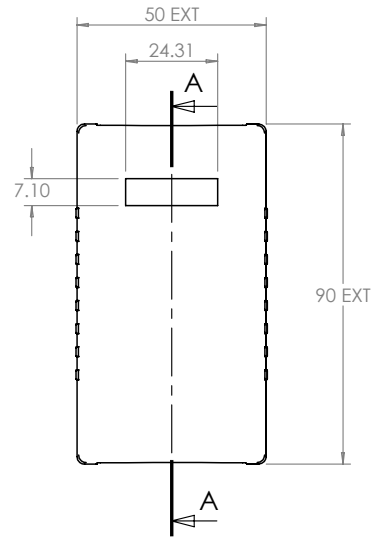

SECTION A-A

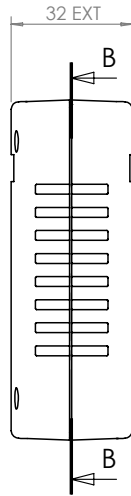
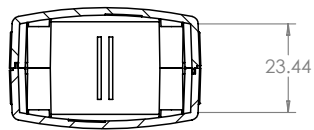

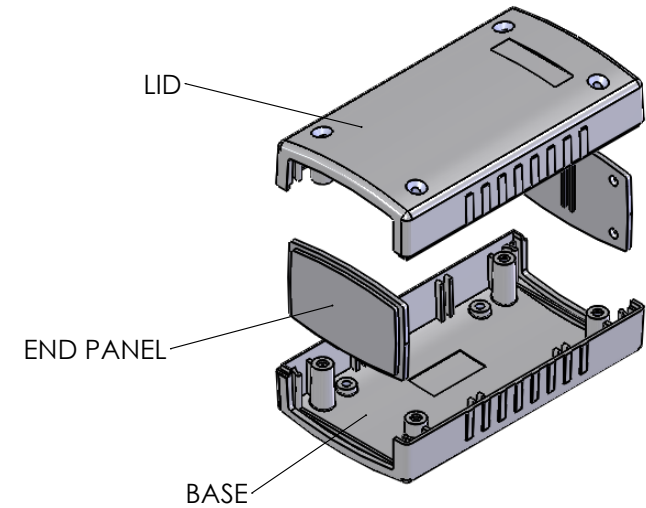
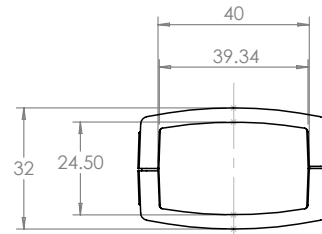
SECTION C-C



 CAMDENBOSS JAMES CARTER RD, MILDENHALL, SUFFOLK. IP28 7DE TEL: 01638 716101 FAX: 01638 716554 EMAIL: Sales@CamdenBoss.com WEB: www.CamdenBoss.com			UNLESS OTHERWISE SPECIFIED: DIMENSIONS ARE IN MILLIMETERS		DO NOT SCALE DRAWING		REVISION. 0					
			GENERAL TOLERANCES +/- 0.2		TITLE: GENERAL ASSY DRAWING FOR 3400 SERIES							
DRAWN L. SUBKHANKULOVA			SIGNED LS		DATE 01/04/11		MATERIAL. UL94-V0		DWG NO. 3400-04		A4	
CHKD -			SIGNED -		DATE -		PROJECTION. 		SCALE: 1 : 2		SHEET 1 OF 1	